

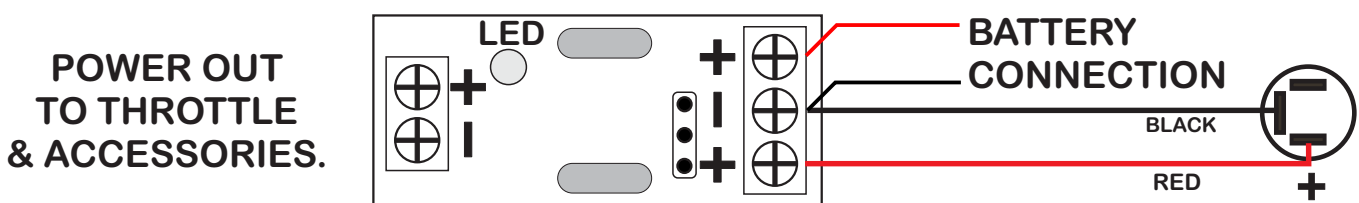

PO BOX 578 CASINO, NSW 2470, AUSTRALIA
 PHONE: INTERNATIONAL ++614 2902 9083
 AUSTRALIA (04) 2902 9083
 Web: <http://www.rcs-rc.com> Email: rcs@rcs-rc.com

RCS # U-BIK-3/6B.
 DIY BATTERY INSTALLATION KIT

This RCS # **U-BIK-3/6B** R/C battery installation kits are either 3 or 6 amp. With a Pre-wired Male - Male servo cable and a cable with a 2.5 x 5 mm socket for charging. The latter accepts most plugs fitted to smart chargers. Each PCB has a pre-mounted SPDT slide switch, 1 x Polyswitch® 3 amp auto reset fuse & screw terminals for Battery & ESC connections. 2 x prs of in line JST connectors. These are also fitted to both COBRA & VIPER ESC's. 1 x Green LED to indicate power ON or OFF. The six amp version will have 2 x 3 amp Polyswitch® fuses. This kit will simplify the installation of battery R/C throttles. It can be used with any brand of R/C or battery type.

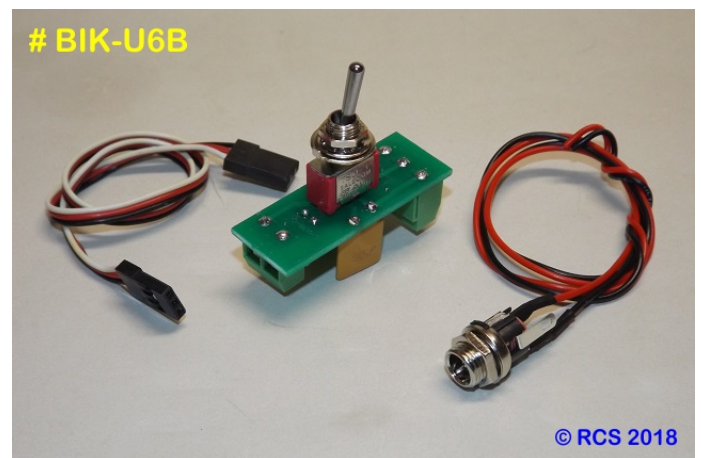
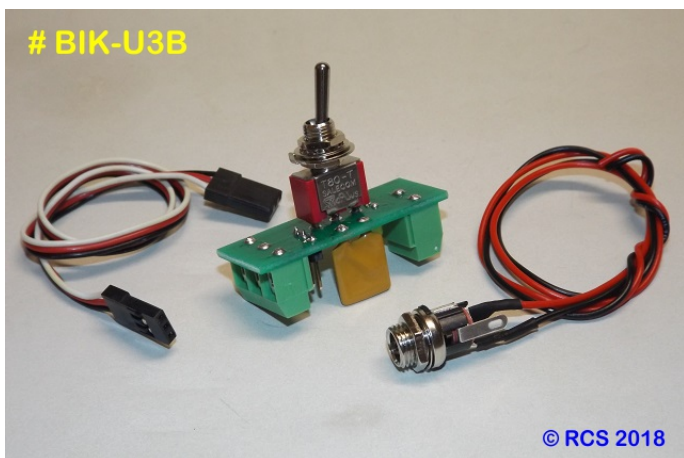

FUSES
 One Orange Polyswitch mean a 3 amp version
 Two orange Polyswitches means a 6 amp version.

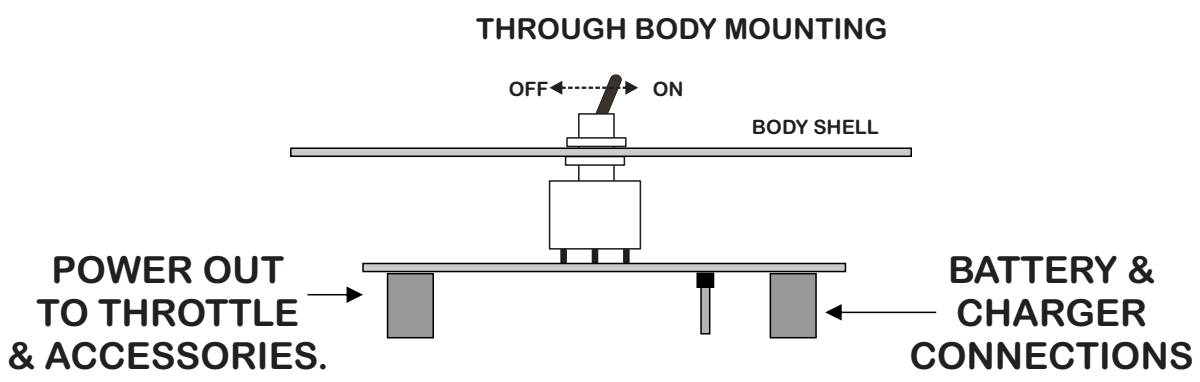

CAUTION!!! Only plug the charger in when the switch is in the OFF Position.

Short Antenna

WIRING THE COBRA ESC 160 by FOSWORKS. HOW TO CONNECT POWER, LIGHTS & SOUND.

Three wire cable. Ensure plugs are correctly located.
Orange/White wire towards top/front of RX.

Be aware that auto bind Rx's have a different servo pin layout.

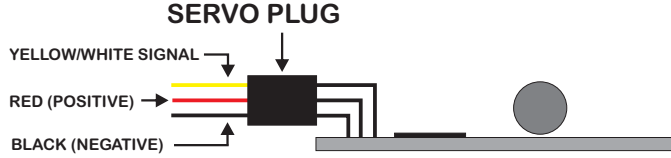

SIDE VIEW OF EM RX. **N.B. 1st version # DSM2-EM-MINI is the other way around.**

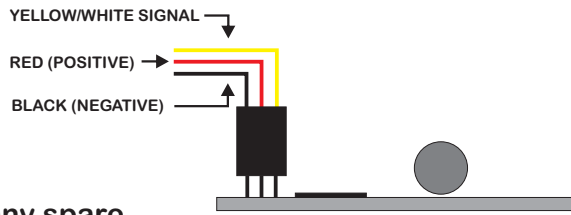

SIDE VIEW OF RA RX

Plug # MRW-SSDS into any spare channel with a centre idle.

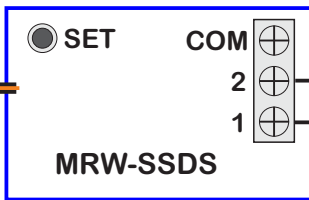

Max 2 amp load on each trigger.

GROUND (-) IS VIA THE SERVO CABLE.

MyLOCOSOUND

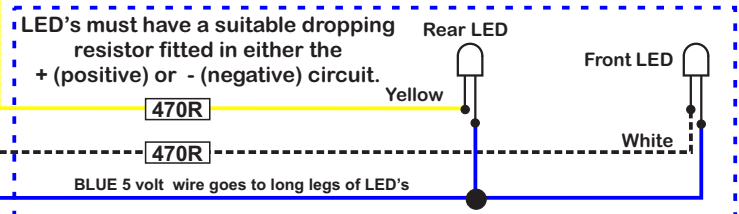
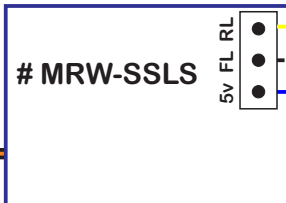
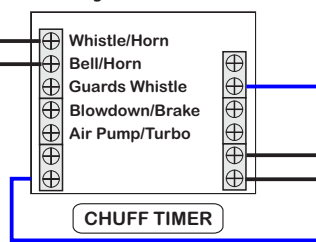

PLUG SPEED & DIRECTION ESC INTO THE THREE PINS ON # SSLS. MATCH WIRE POLARITY.

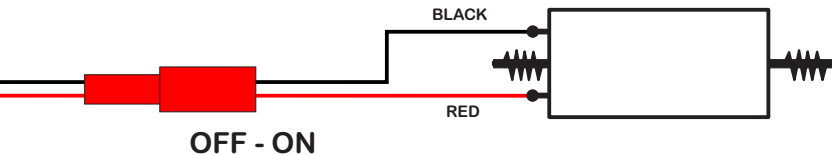
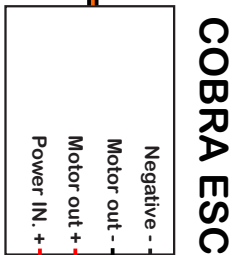

POWER OUT TO THROTTLE & ACCESSORIES.

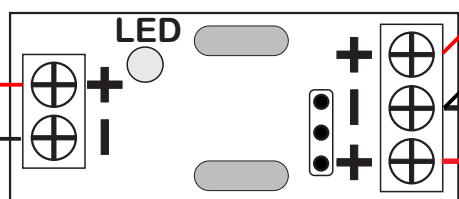

BATTERY CONNECTION

FUSES

One Orange Polyswitch mean a 3 amp version
Two orange Polyswitches means a 6 amp version.