

WIRING THE *RCS-BELTROL* BTL-3r ESC with battery power & Sierra sound.

N.B. It is OK to swap outputs #1, #2, #3 & #4 to suit TX sticks.

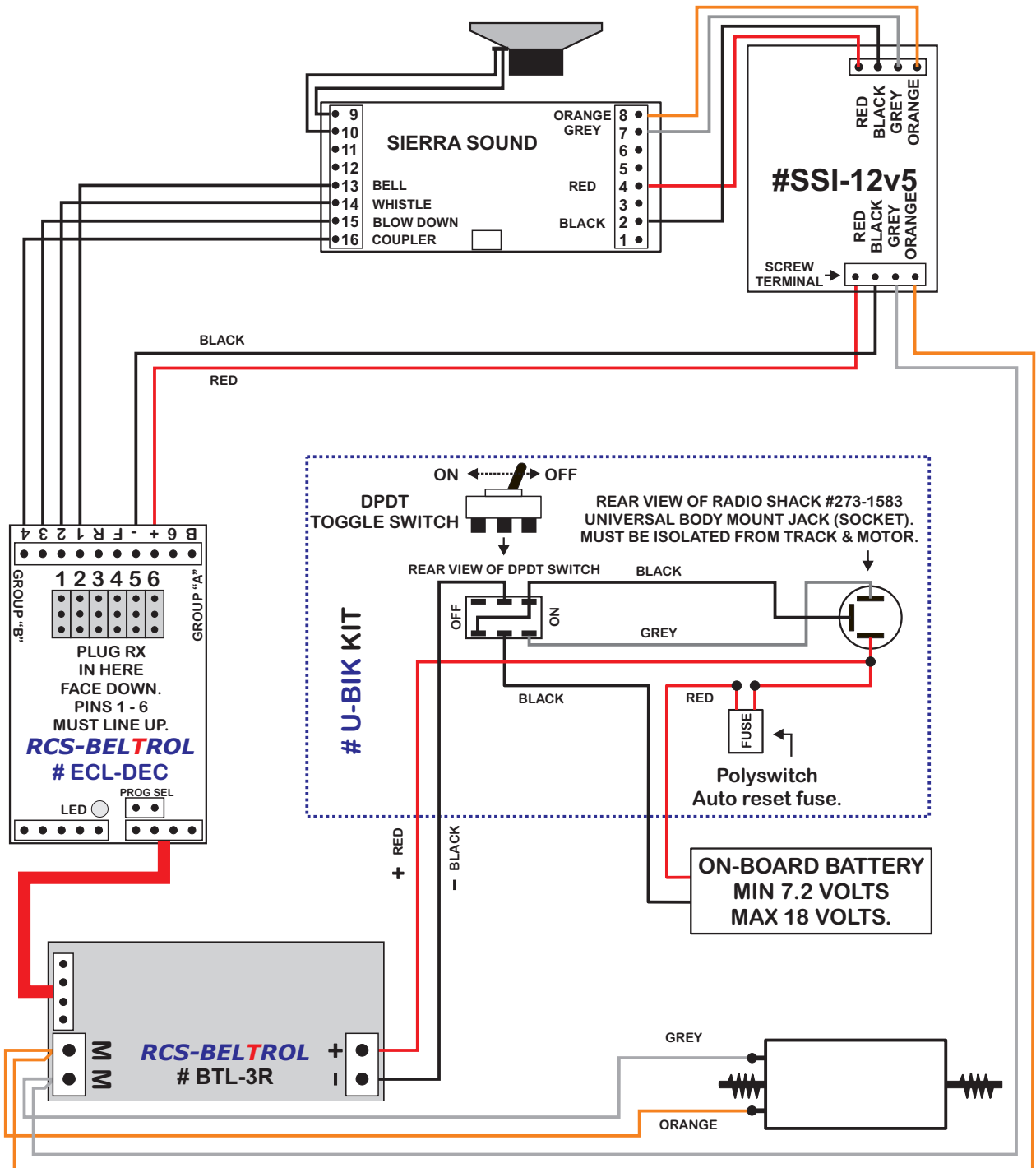

CAUTION:

SPEKTRUM® R/C & PLANET TWISTER® R/C ARE GROUP "A" SYSTEMS.
THEY MUST USE THE **BTLvA2** PROGRAM.
HOBBY KING® R/C & E-SKY® R/C ARE GROUP "B" SYSTEMS.
THEY MUST USE THE **BTLvB2** PROGRAM.